

OSKAR

air products

www.oskarairproducts.com • info@oskarairproducts.com

Single pivot extension boom 10200

301101344 • Diameter 200 mm
• Reach 1 m

A - Inlet flange
B - Outlet flange
C - Mounting bracket

Standard construction:

- galvanized spiral tube on the support beam
- heavy duty steel closed profile support beams with metal counter support rod and inlet socket for 200 series extraction arms
- all supports and adjustments on the outside
- welded steel boom mounting bracket with top or bottom outlets
- rigid bearings with friction discs
- black PVC flexible hoses (temperature resistance up to 80°C)
- load capacity of 50 kg

Notes:

The method of packing and carton sizes:

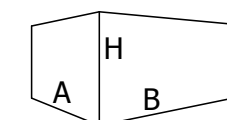

A = 330
B = 1720
H = 1000
weight = 80 kg

All dimensions are given in **mm**.

Menegon Sp z o.o.
Mokry Dwór 6C, 80-021 Wiślina, Polska
tel.: +48 58 3012838, fax +48 58 3059324
info@menegon.com.pl, www.menegon.com.pl

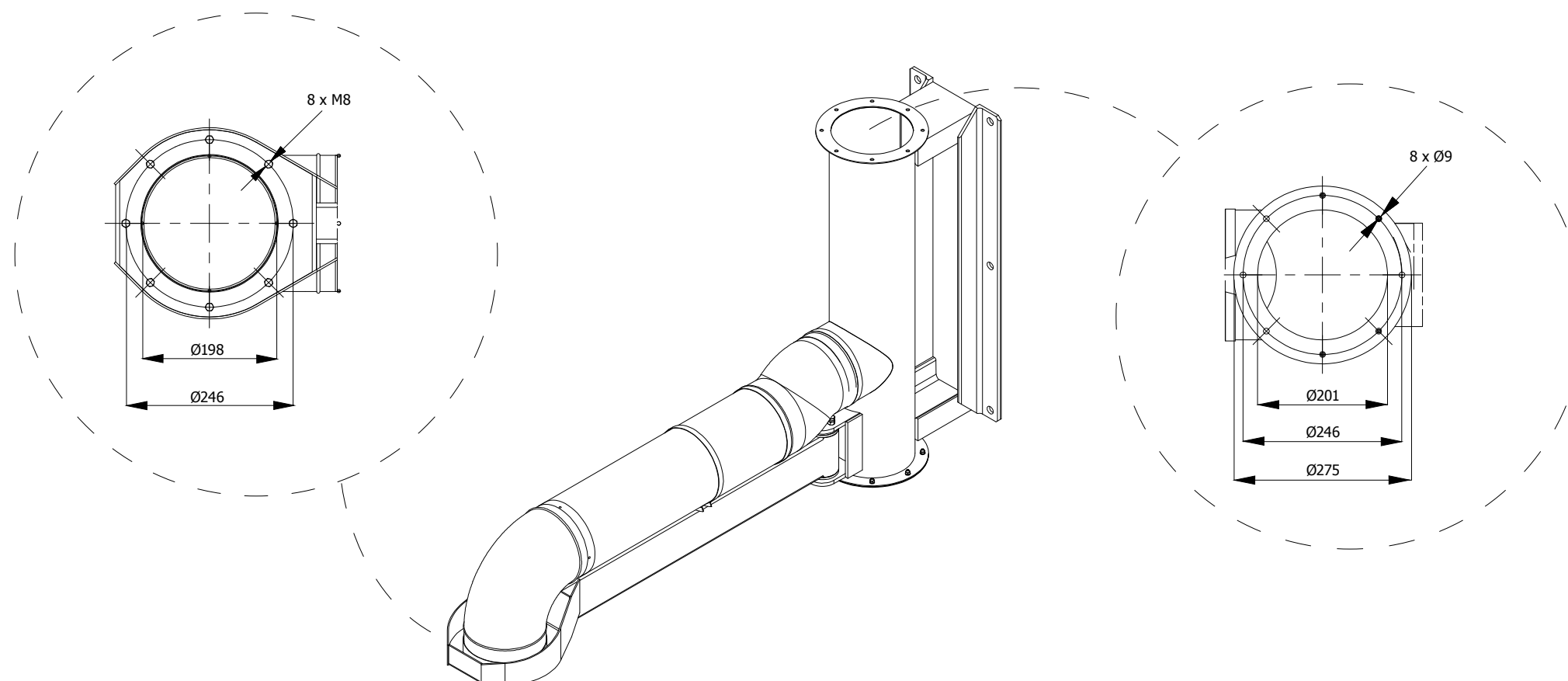
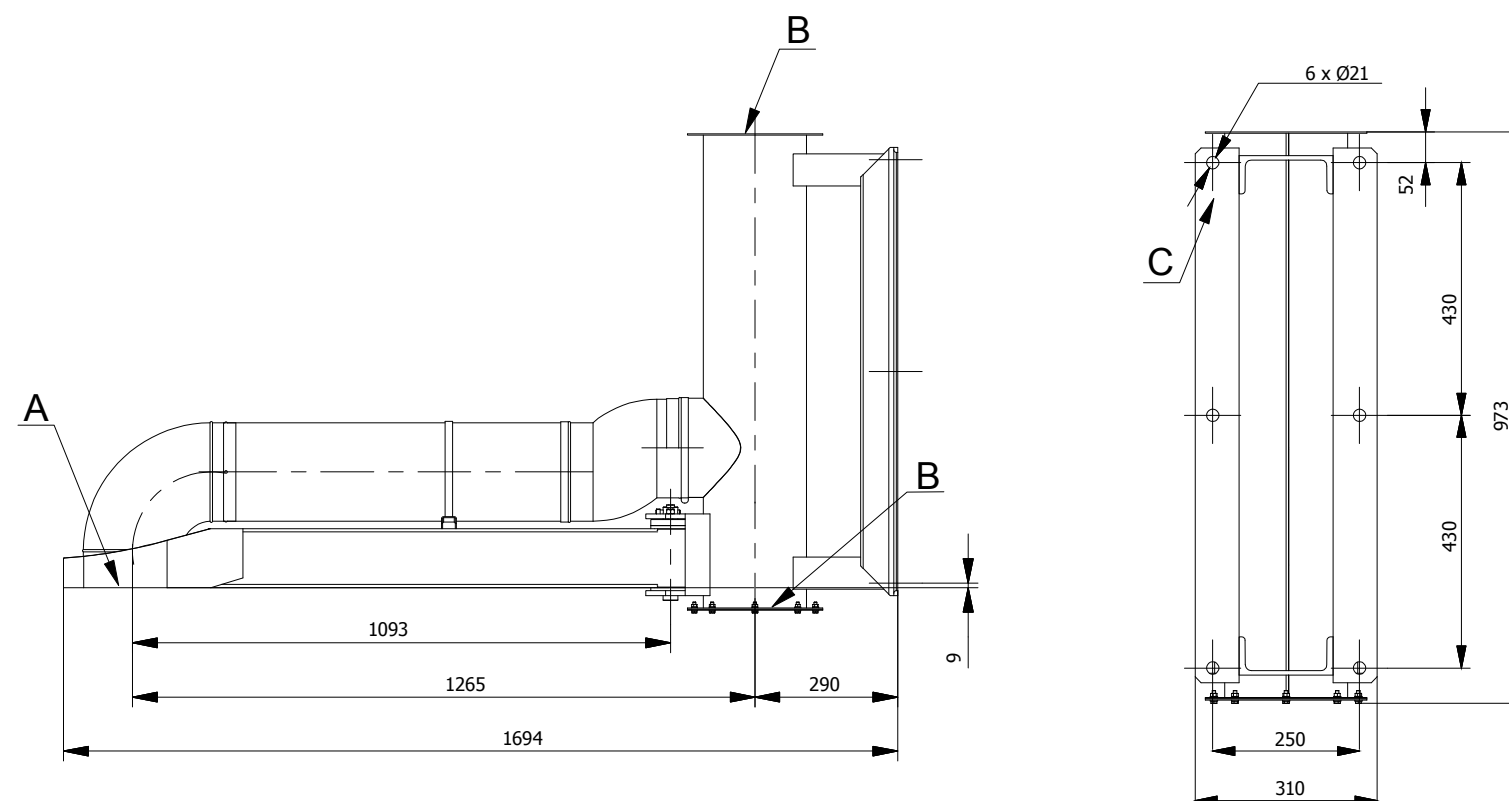

All rights reserved. This document including constructional and technical information as well as Oskar Air Products, Menegon and czystepowietrze.pl trademarks and brand names are law protected and are property of Menegon Sp.o.o.